

**PB 1058LE-AG**

**Lumberg Automation™  
M12 Angle Connectors  
with 360° Shielding**

Equipped with 360° shielding and the highest industrial protection class IP69K, the new angle connectors and couplers reliably secure transmission of analog and digital data, even in harsh industrial environments.



**Right Angle Male and Female Connectors Shielded Fully Using Knurled Nuts/Screws and Based on Proven M12 Technology are now Available to Fulfill the Most Stringent EMC Requirements, Thanks to Their Patented Shielding Concept.**

- Secure data transmission of analog and digital signals for maximum efficiency and functional reliability.
- Industrial protection class IP69K allows the use of the 360° shielded connectors even under the harshest environmental conditions and thus opens up new markets.
- Shock and vibration resistance ensure increased machine uptime.

Whether angled or straight in design, the M12 connectors for transmission of digital and analog signals enable fully shielded connections from one device to the next in automation technology. Bus modules (Profibus, ProfiNet), passive distribution boxes and control cabinets, as well as sensors and actuators, can be connected in the field. The angled design of the male and female connectors allows convenient assembly even in confined spaces.

The angle male and female connectors with threaded joint and molded cable guide the shield using the knurled nuts/knurled screws, just as with the straight versions. The rugged design withstands even high pressure and steam cleaners and is extremely resistant to vibration.

**Applications**

Automated systems in food processing, packaging, machine tool engineering, automobile manufacturing and many other

industries work at extremely high speeds and often create strong vibrations. Process reliability and system availability are assured with the new connectors, thanks to their optimally secure data transmission and extremely robust design.

Confined spaces and complex cable runs in installations and handling systems are typical with growing levels of automation. Such applications can often be realized more efficiently with angled connectors, without sacrificing safety. The patented shield concept and mechanically robust construction of the angle connectors and couplers allow reliable and safe operation, even in harsh industrial environments.

**Your Benefits**

Design engineers and service technicians are very familiar with the standardized M12 connection technology and its flexible field of application. With the new 360° shielded male and female right angle connectors, highly secure data transmission is also possible, even if the available installation space is limited or there is a risk of cable breaks.

Highest EMC compatibility – even in harsh environments where industrial protection class IP69K is required – together with the proven, robust M12 connectors, guarantees maximum functional reliability and safety.



## M12 Male and Female Right Angle Connectors with 360° Shielding

The standardized M12 connection technology allows the fast and uncomplicated assembly of shielded control systems with analog or digital components. This also applies when using male and female angled connectors, which are equipped with the patented 360° shielding. Technicians can choose between cordsets with straight and angled connectors and connecting cables with the connector combinations straight/straight, angle/straight and angle/angle. Maximum robustness and ease of installation, even in confined spaces, make the connection technology suitable for use in harsh industrial environments.

Robust EMC networks for automation technology in industrial environments can be set up, for example, in conjunction with switches from the Hirschmann™ Octopus series. All components fulfill RoHS and REACH requirements.

Variants are available with 4, 5 or 8 poles and codings for actuator/sensor (A), Profibus (B) and ProfiNet (D). The products for bus systems are black in color, while those for actuator/sensor connectors are orange.

Enhanced safety in the operation of equipment, machinery and systems, thanks to EMC, shock and vibration resistance and optimum protection rating of connection technology.







### Benefits at a Glance

- Very high EMC resistance, true 360° shielding
- High mechanical quality, resistance to shocks and vibrations (DIN EN 61076-2-1-101, DIN EN 60068-2-64, DIN EN 60028-2-27)
- Industrial protection class IP67, IP68 and IP69K (in accordance with IEC 60529 and DIN 40050-9)
- Very safe operation thanks to the combination of high mechanical strength and protection against electro-magnetic radiation
- Available with 4, 5 or 8 ports as male or female connector
- Differently colored variants for bus systems and analog connections
- Codings for different bus systems
- Operating temperature range of -25°C to +85°C
- Perfect addition to the switches from the Hirschmann™ Octopus series





## Technical Specifications

Product Description					
Type	RKWTS	RSWTS	0975 254 151 (RKWTS 5B)	0975 254 152 (RSWTS 5B)	0985 342 106 (RSWTS 4D)
	 	 	 	 	 
<b>Description</b>	Actuator/sensor cordset, M12 female right angle connector with threaded joint and molded cable, 360° shielding connected to knurled nut	Actuator/sensor cordset, M12 male right angle connector with threaded joint and molded cable, 360° shielding connected to knurled screw	Profibus signal cable, M12 female right angle connector B coded, molded on one side, 360° shielding connected to knurled nut	Profibus signal cable, M12 male right angle connector B coded, molded on one side, 360° shielding connected to knurled screw	Industrial Ethernet data cable, M12 male right angle connector D coded, molded on one side, 360° shielding connected to knurled screw
Technical Data					
<b>Operating Temperature</b>	-25°C to +85°C				
<b>Housing/Molded Body</b>	TPU, orange	TPU, orange	TPU, black	TPU, black	TPU, black
<b>Insert</b>	PBT, black	PBT, black	PBT, violet	PBT, violet	PBT, black
<b>Contact</b>	CuSn 4 to 5 poles, CuZn 8 poles	CuSn 4 to 5 poles, CuZn 8 poles	CuSn	CuSn	CuSn
<b>Contact Surface</b>	Cu/Au				
<b>Receptacle Shell/Knurled Screw/-nut</b>	CuZn, nickel-plated				
<b>Shield Sleeve</b>	CuZn, tin-plated				
<b>O-Ring</b>	FKM				
Mechanical Data					
<b>Protection Class</b>	IP67, IP68, IP69K (IEC 60529)				
Electrical Data					
<b>Contact Resistance</b>	≤ 5 mΩ				
<b>Nominal Current</b>	4 to 5 poles 4 A, 8 poles 2 A	4 to 5 poles 4 A, 8 poles 2 A	4 A	4 A	4 A
<b>Rated Voltage</b>	4 poles 240 V AC/DC 5 poles 60 V AC/DC 8 poles 30 V AC/DC	4 poles 240 V AC/DC 5 poles 60 V AC/DC 8 poles 30 V AC/DC	60 V AC/DC	60 V AC/DC	240 V AC/DC
<b>Test Voltage</b>	4 poles 2.0 kV 5 to 8 poles 1.5 kV	4 poles 2.0 kV 5 to 8 poles 1.5 kV	1.5 kV	1.5 kV	2.0 kV
<b>Insulation Resistance</b>	>10 <sup>9</sup> Ω				
<b>Pollution Degree</b>	3 DIN EN 60664-1 (VDE0110)				

## Technical Data

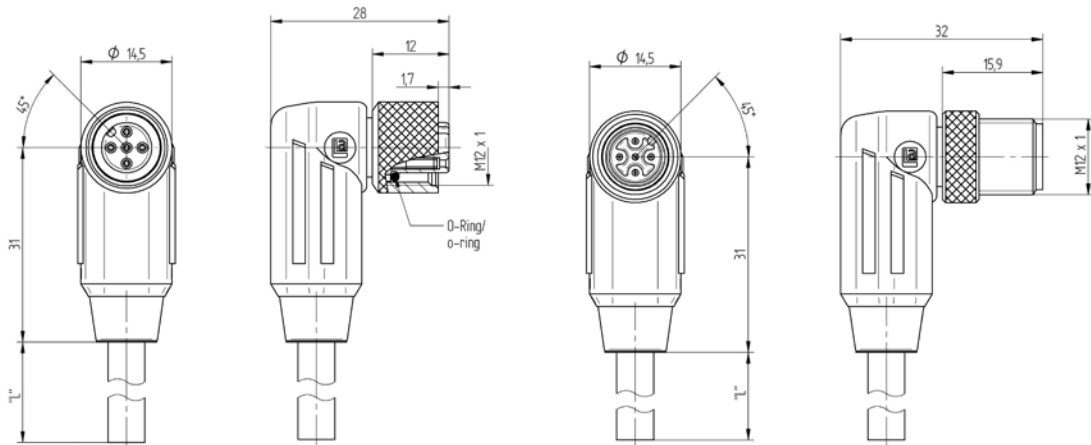

## Belden® Connectivity Center

Nowadays it is more important than ever to continuously increase the efficiency of production processes. Safe, cost-effective connectivity solutions for your machinery and plant play an important role in achieving this. Customized solutions tailored to your individual requirements enable you to substantially reduce your total cost of ownership. Thanks to the Belden Connectivity Center, the only one of its kind in the market, we are your worldwide partner when it comes to implementing such solutions, flexibly and rapidly, whether you need customized connectors and cable assemblies, or active and passive I/O modules for fieldbus or Ethernet networks – always in line with our motto "listen, understand, implement and deliver." You will benefit both from the expertise of our knowledgeable specialists and from our extensive experience as a leading supplier of high-quality automation components. Let us utilize your challenges for our mutual success.

### Always the Right Solution

Belden is the world's leading supplier of signal transmission solutions including cable, connectivity and active components for mission-critical applications ranging from industrial automation and alternative power generation through to professional broadcasting. Belden offers an extensive portfolio of highly specialized products for steering, control and field level, which the company produces and markets under its proprietary Belden®, Hirschmann™, and Lumberg Automation™ brands. We would be glad to give you a more personal introduction to our integrated product palette for industrial applications and the worldwide Belden Service

You will find further information and technical details online at [www.lumberg-automationusa.com](http://www.lumberg-automationusa.com) or contact our Sales Team directly: **Tel. 717.217.2272.**